

WOFD Fall 2017

* In Stock Products

AIR

Desking & Tables

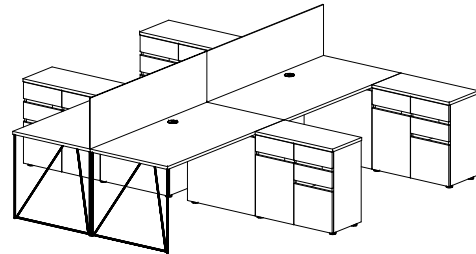

JAZZ & LIGHT

High Tables

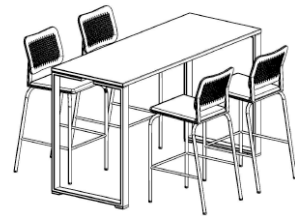
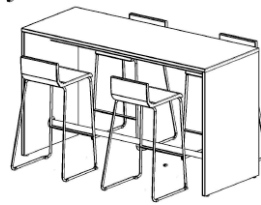

CHOICE

Modular Storage

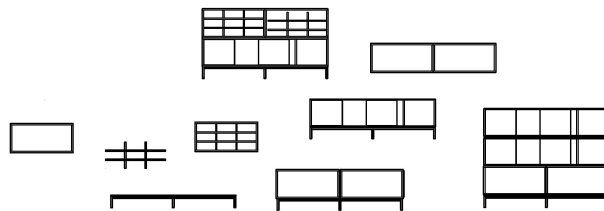

Wholesale Office Furniture Distributors

400 Glover Street SE Marietta, GA 30060

p. 800.288.96

f. 7 0.429.1204

www.wofd.com

* In Stock

10/1/17



High Tables

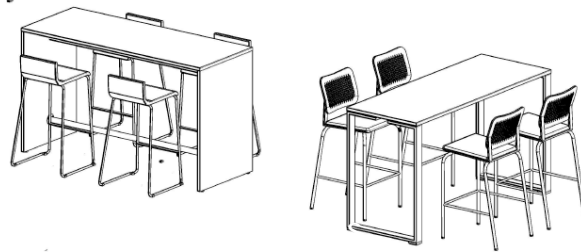

Painted metal part	
E - Black	M1 - White
Melamine	
M1 White	
List Price	

Description	Dimensions, mm	Components	Code	Quantity	Item's code	List Price
-------------	----------------	------------	------	----------	-------------	------------

JAZZ *In Stock, Finishes White Melamine with Black Legs

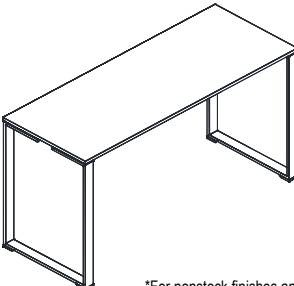
 <p>High table Melamine surface with metal frame and O shape legs.</p> <p>*For nonstock finishes and sizes standard lead times apply</p>	<p>70.9"x27.6", H=40.6"</p>	Desktop	G2A766	1	CGM180	705
		Metal frame	G2R112	1		
		Set of legs	G3C271	1		

LIGHT *In Stock, Finishes White Melamine with White Legs & Metal Parts

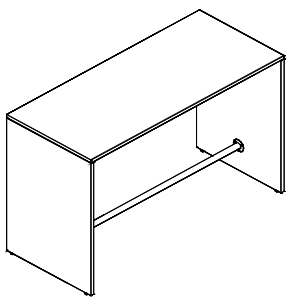
 <p>High table Melamine surface and legs. Metal frame and foot rest.</p> <p>*For nonstock finishes and sizes standard lead times apply</p>	<p>63"x27.6", H=41.3</p>	Desktop	G2A842	1	CTM180	475
		Metal frame for legs	G2R113	1		
		Set of legs (2 pcs.)	G3D040	1		



* In Stock

10/1/17

Select components in stock from the AIR Furniture System

AIR Desking & Tables

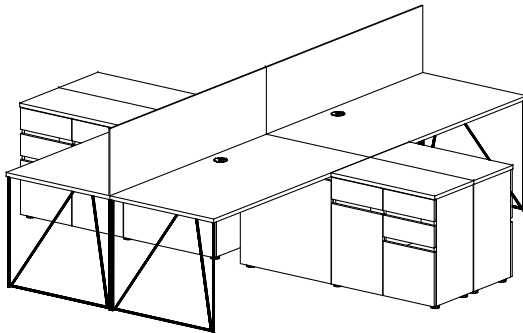

Painted metal part
E- White
Melamine
M1 White
List Price

Description	Dimensions,	Components	Code	Quantity	Item's code	List Price
-------------	-------------	------------	------	----------	-------------	------------

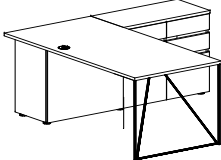
AIR *In Stock, Finishes White Melamine with White Legs & Metal Parts						
 <p>Overall - 63"x63",H=29.1" Desk - 63"x31.5",H=29.1" Credenza - 63"x 59"x 15 .75",H=29.1" *Credenza ships assembled</p>						
			G2A619	1	PNS3176M1E	1375
		Credenza cabinet 59.1"L	G1B197	1		
		Leg	G3B074	1		
Left Hand 63"x63"x 29.5" Desk. Features, built in wire management, signature Air leg support and Credenza Cabinet. Cabinet includes 1) BBF with lock, 1) box drawer with lower cabinet and 1) large storage or CPU cabinet.						
* For non stock finishes and sizes standard lead times apply * Harnessed power systems from ECA are available and ships within 2 weeks Contact WOFD Customer service for details.						

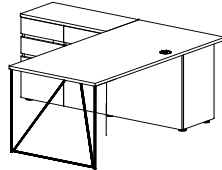
AIR *In Stock, Finishes White Melamine with White Legs & Metal Parts						
 <p>H=29.1"</p> <p>Overall - 63"x63",H=29.1" Desk - 63"x31.5",H=29.1" Credenza - 63"x 59"x 15 .75",H=29.1"</p>						
			G2A619	1	PNS3175M1E	1375
		Credenza cabinet 59.1"L	G1B197	1		
		Leg	G3B074	1		
Right Hand 63"x63"x 29.5" Desk. Features, built in wire management signature Air leg support and Credenza Cabinet. Cabinet includes 1) BBF with lock, 1) box drawer with lower cabinet and 1) large storage or CPU cabinet.						
* For non stock finishes and sizes standard lead times apply * Harnessed power systems from ECA are available and ships within 2 weeks Contact WOFD Customer service for details.						

Screens & Modesty panels

Description	Dimensions	Components	Code	Quantity	Item's code	White Frosted	Acrylic
						List Price	
Acrylic modesty panel for desk(edge w=63" in.)Square edge. Hardware included.	50.1" H=11.8"	Modesty panel	G4B099	1	DIK130		175
Acrylic screen for desks. Use only with double benches between desks (edges w=63" in)Square edge. Hardware included.	63" H=14 H"	Screen for double benches	G4B102	1	DNK171-R01		530
Acrylic screen for desks. Use only for mounting between credenza cabinets (edges w=63" in). Square edge. Hardware included.	63" H=14 H"	Screen for credenza cabinets	G4B102	1	DNK171-SM		600

* In Stock

10/1/17

Select components in stock from the AIR Furniture System

AIR Conference Table

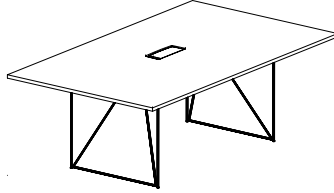

Painted metal part

E- White

Melamine

M1 White

List Price

Description	Dimensions,	Components	Code	Quantity	Item's code
-------------	-------------	------------	------	----------	-------------

AIR *In Stock, Finishes White Melamine with White Legs & Metal Parts

Meeting table (8 seats) with aluminum grommet box

86.6"x50.1"
H=29.1"

Desktop with metal frame G2A608 1

Set of legs G3B073 1

Frame G6F148 1

CIM220

875

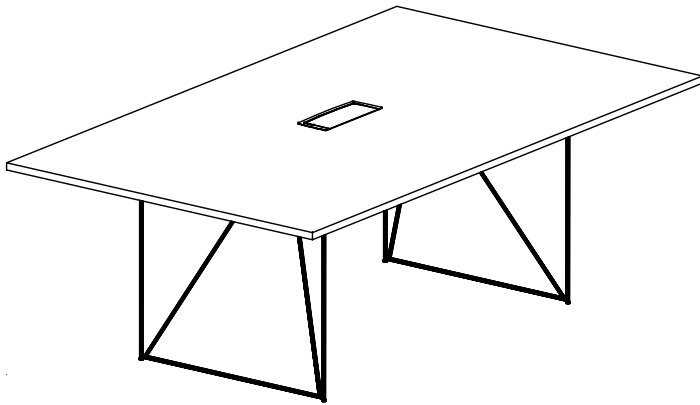

*For nonstock finishes and sizes standard lead times apply Powered Grommets from ECA available and ship within 2 weeks. Contact WOFD Customer service for details.

* In Stock

10/1/17

Select components in stock from the AIR Furniture System

AIR Desking & Tables

AIR Credenza Cabinet Features

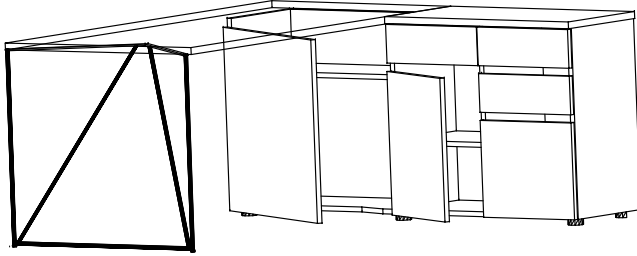

AIR Screens & Modesty Panel Applications

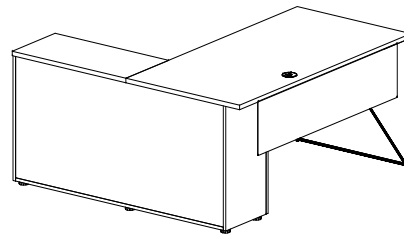
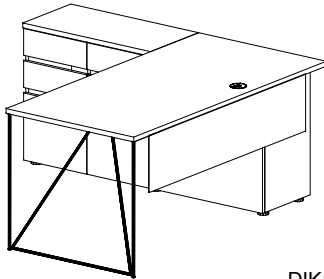
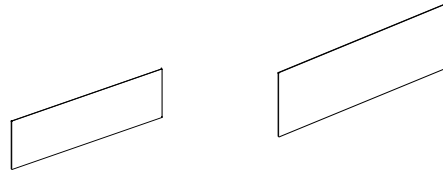

DIK130 Acrylic modesty panel for desks

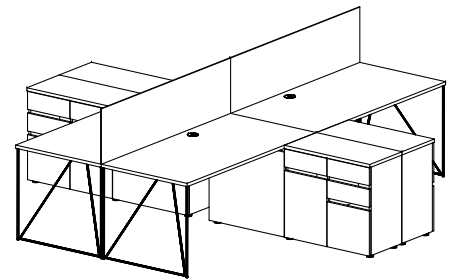
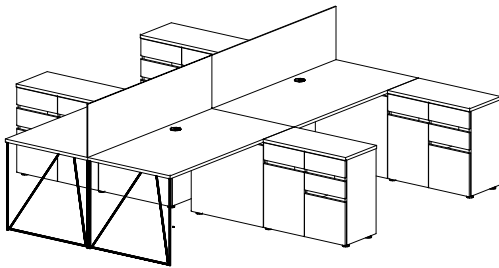

DNK171-R01 Acrylic screen for between desks

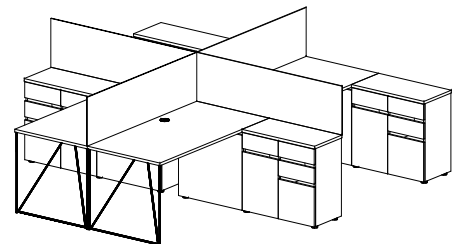
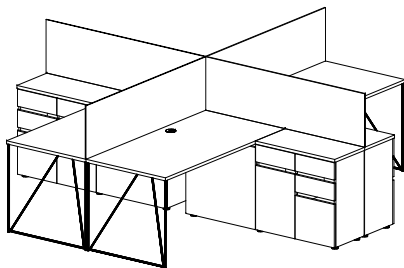



DNK171-SM Acrylic screen for mounting between credenza cabinets

*In Stock

10/1/17

A sampling of functional products from Choice, a universal storage system

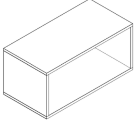
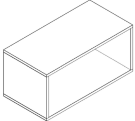
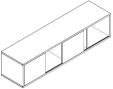
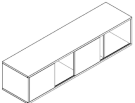
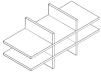
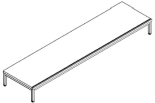
Storage CHOICE

Description	Dimensions, In	Components	Code	Quantity	code	Painted metal part
						List Price
 <p>Open Bookcase (without base). Can be mounted in combinations to frames. Can be fixed ed onto another and used in stacking combinations. Stacking hardware sold seperatley</p>	31" 1/2"x15" 3/4", H=14" 1/2"	Bookcase	G1B350	1	C1N080	95
* Ships assembled For nonstock finishes and sizes standard lead times apply						
 <p>Open Wall mount Bookcase.Pre installed mounting hardware included. Cannot be used in stacking combinations.</p>	31" 1/2"x15" 3/4", H=14" 1/2"	Bookcase	G1B349	1	C1N070	125
For nonstock finishes and sizes standard lead times apply						
 <p>Cabinet with 2 sliding doors (without base). Can be mounted in combinations to frames. Can be fixed ed onto another and used in stacking combinations. Stacking hardware sold seperatley</p>	63x15" 3/4", H=14" 1/2"	Cabinet with 2 sliding doors	G1B357	1	C1S160	255
For nonstock finishes and sizes standard lead times apply						
 <p>Open Wall mount Bookcase.Pre installed mounting hardware included. Cannot be used in stacking combinations.</p>	63x15" 3/4", H=14" 1/2"	Cabinet with 2 sliding doors	G1B339	1	C1S160	325
For nonstock finishes and sizes standard lead times apply						
 <p>Pigeon holes storage for all open 31" 1/2" wide wall mounted or standing.</p>	30"x12" 1/4", H=12" 3/4"	Pigeon holes	G1B449	1	C0Z049	55
For nonstock finishes and sizes standard lead times apply						
 <p>Metal frame with feet and central leg for 31" 1/2" & 63" wide cabinets</p>	63"x15" 3/4", H=6"	Metal frame with feet and central leg	G1M025	1	C0Z162	75
For nonstock finishes and sizes standard lead times apply						
 <p>Stickers for cabinet fixing onto another (6pcs.)</p>		Stickers for cabinet fixing onto another (6pcs.)	G6F383	1	C0Z053	10

*In Stock

10/1/17

A sampling of functional products from Choice, a universal storage system

Storage CHOICE

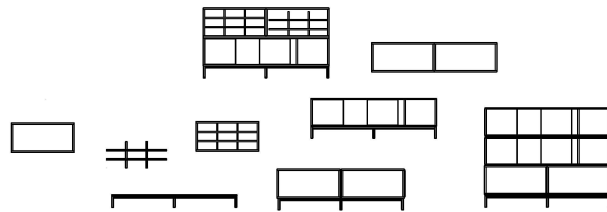

CHOICE

Create Endless Options with Only 7 Components

- Free Standing Configurations 1H to 5H
- Wall Mounted Solutions in 31.5" - 63"W

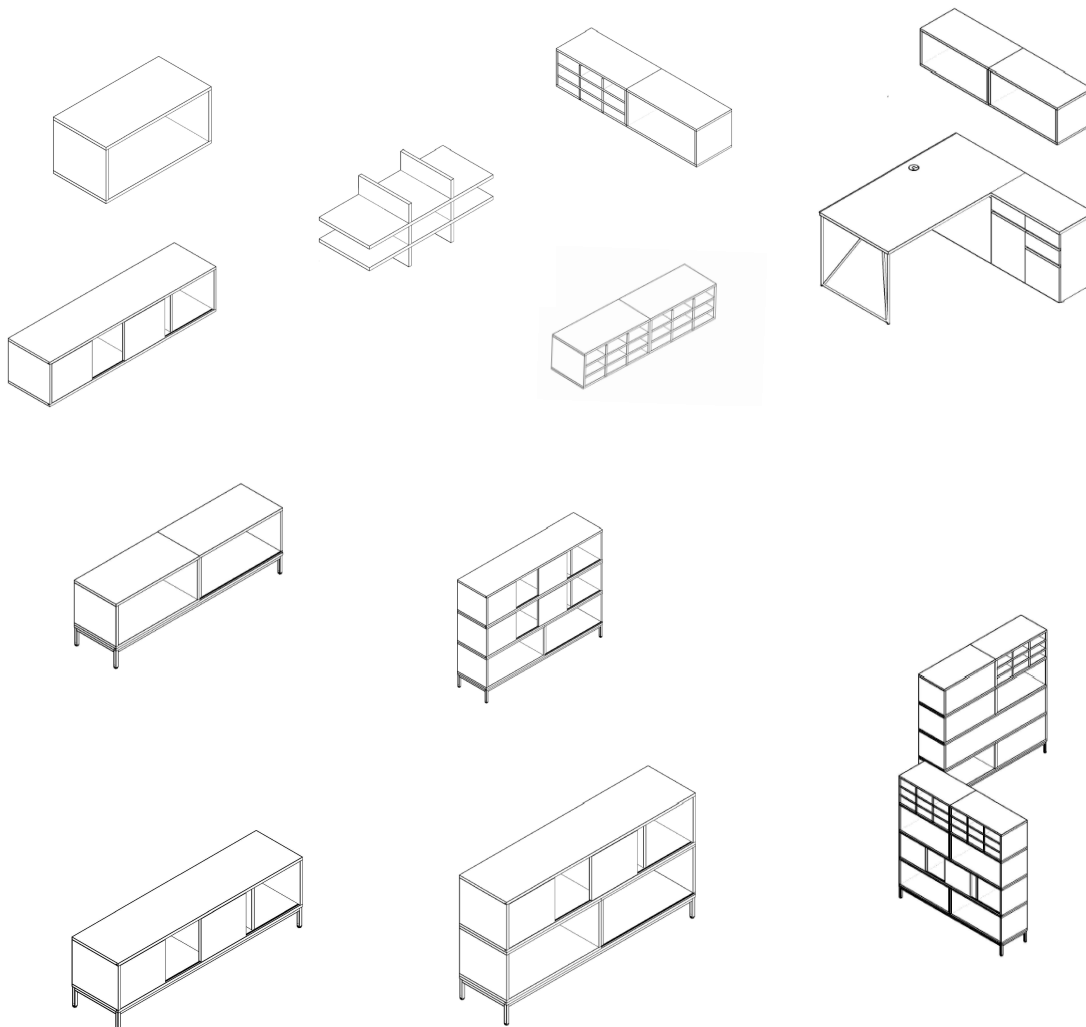

WOFD Product Warranty

WOFD products are backed by our Limited Lifetime Warranty for as long as you, the original purchaser, own it. We will repair or replace any product or component that is defective in material or workmanship subject to the provisions below.

Limitations

The following materials and components are covered for 5 years from the date of sale:

- glides, casters, panel & seating fabrics, foam, and other covering materials.

The following components are covered for 10 years from the date of sale:

- Laminates, veneer, membrane, HPL, drawer slides.

The following components are covered for 10 years from the date of sale:

- electrical components

Exclusions

This warranty does not apply to:

- Normal wear-and-tear, which is to be expected over the course of ownership.
- Damage caused by the carrier in-transit, which will be handled under separate terms.
- Modifications or attachments to the product that are not approved, in writing, by WOFD that were not installed, used or maintained in accordance with product instructions and warnings.
- Products used for personal or household use or for rental purposes.
- Customer's Own Material (COM) selected by and used at the request of the owner.
- Product used in applications requiring greater than a single shift (40-hour work week), except for models specifically designed for multiple shifts.

To the extent allowed by law, Wholesale Office Furniture Distributors, Inc. (WOFD) makes no other warranty, either expressed or implied, including any warranty of merchantability or fitness for a particular purpose. WOFD will not be liable for any consequential or incidental damages.

This warranty applies only to products sold within the United States of America, territories of the United States of America and the Commonwealth of Canada.

To Obtain Service Under this Warranty

Your WOFD dealer is our partner in supporting your warranty requests. Follow the procedures outlined below for the best level of service:

Contact the dealer from whom the product was purchased within 30 days of discovery of the defect. Be prepared to affirm you are the original purchaser of the product and to provide the invoice number(s) from the product(s) in question.

Your dealer will gather all pertinent information regarding the claim, inspect the product, and contact WOFD Customer Relations. (Please allow a reasonable amount of time for inspection and review.)

If WOFD affirms that the product in question is eligible under the conditions of the warranty as stated above, a WOFD representative will determine whether to provide replacement parts, authorize repairs or replace the product.

WOFD Freight Program

AMOUNTS LISTED BELOW REPRESENT NET ORDER VALUES

	ZONE 1	ZONE 2	ZONE 3	ZONE 4
SHIP TO:	GA, SC, NC, AL, MS AND EAST TN (GREATER NASHVILLE AND EAST OF I-65)	FL (TAMPA NORTH), WEST TN, LA, AR, VA	SOUTH FL, KY, EAST TX (EAST OF I-35 GREATER DALLAS AND FT. WORTH), MD, PA, DE, OH, IN, MO, OK, CT, IA, IL, KS	ALL OTHER STATES (CONTINENTAL USA ONLY)
LTL:	\$1,500 – \$9,999 = 5% \$10,000 - \$19,999 = 4% \$20,000 - \$30,000 = 3% Truckload (Over \$30,000) = 2.5% Net order	\$1,500 – \$9,999 = 8% \$10,000 - \$19,999 = 6% \$20,000 - \$30,000 = 4% Truckload (Over \$30,000) = 4% Net order	\$1,500 – \$9,999 = 10% \$10,000 - \$19,999 = 8% \$20,000 - \$30,000 = 6% Truckload (Over \$30,000) = 5% Net Order	\$1,500 – \$9,999 = 15% \$10,000 - \$19,999 = 13% \$20,000 - \$30,000 = 11% Truckload (Over \$30,000) = 10% Net order
LTL Orders less than \$1,500 Net:	\$100 Surcharge*	\$125 Surcharge*	\$175 Surcharge*	\$250 Surcharge* + 15%Net Order

* Orders above \$50,000 net in Zones 1, 2 and 3 may be subject to a waived or reduced freight fee. For inquiries contact WOFD customer service or your WOFD sales representative.

FREIGHT PROGRAM EXCLUSIONS:

Small parcel orders less than \$1500 net such as single chairs will be sent UPS and actual freight will be billed to the customer. This will only be considered if appropriate to ship the item UPS and if the UPS fee is less than the Zone surcharge.

Deliveries under \$30,000 net to New York area codes ending in: -100, -101, -102, -103, -118, or -119 will incur \$100 fee added to the Zone 4 program.

Deliveries under \$30,000 net to the District of Columbia (DC) will incur \$100 additional fee added to Zone 3 program.

Due to their excessive weight and or cubes, work surface-only orders and orders consisting of 12 or more lateral files (2, 3 and 4 drawer) will be excluded from all freight programs. A freight quote will be provided for these orders and the actual freight will be billed to the customer.

LTL and Truck load additional services such as Lift-gate, inside delivery, residential delivery, limited access etc are an additional fee and will be charged to the customer. These services must be specified at order submission. Service charges will vary depending on the service type and the carrier. For service charge inquiries please contact WOFD customer service. WOFD will not incur the costs for unforeseen issues neglected by the purchaser, including those previously stated as well as re-consignment fees, re-delivery fees and any other charge that may have been handled with complete information about the delivery location.

LTL Delivery appointments generally add 1 business day to standard transit times and can incur additional charges depending on the carrier. Truckloads may be scheduled without additional fees or transit times. Because of delivery delays beyond the carriers control such as weather, accidents, construction ect delivery appts should be expected to arrive within a 4 hour period from appt time. Please make sure appropriate measures are taken by receiving to insure detention fees are not incurred. WOFD will not take responsibility for delays due to weather, accidents, construction and any other factor beyond our control.

Please note: for LTL deliveries allow 15 minutes waiting and unload time. Dedicated (truckload) deliveries allow 2 hours waiting and unload time. After the allotted time, the customer will be responsible for any detention fees. It's recommended having a receiving dock with a height of at least 10' and a pallet jack or fork lift available at the time of delivery.

CLAIMS AND RESPONSIBILITY

Any shipments received with visible carton damage or shortages must be noted as "damaged" or "short" on the bill of lading and signed by the receiving agent, as well as the carrier. The damaged cartons should then be inspected immediately to determine if there is product damage. If there is obvious product damage to the shipment upon receipt, refuse the shipment and note on the bill of lading "damaged and refused" before signing. An inspection of the contents of all cartons immediately upon arrival is recommended. WOFD must be notified within 5 working days after product is delivered if any shortages or damages were found (including concealed damage that does not become apparent until the product is unpacked). Failure to note shortages and damages on the bill of lading and/or failure to notify WOFD within 5 working days after shipment receipt constitutes a waiver of claim. Freight claims for third party and/or collect shipments are the responsibility of the customer. Contact Customer Support at 800-288-9633 if shipment is not received within 10 days of shipment.